

SPICE thermal model

BUK7M33-60E

Symbol	Parameter	Conditions	Min	Typ	Max	Unit
$R_{th(j-mb)}$	thermal resistance from junction to mounting base		-	-	3.40	K/W

C_{th1}	1.254E-05 F
C_{th2}	1.257E-04 F
C_{th3}	7.908E-05 F
C_{th4}	5.371E-02 F
C_{th5}	4.805E-04 F
C_{th6}	1.086E-02 F
C_{th7}	2.098E-02 F
C_{th8}	3.685E+03 F
R_{th1}	6.283E-03 Ω
R_{th2}	1.024E-02 Ω
R_{th3}	7.854E-02 Ω
R_{th4}	2.335E-03 Ω
R_{th5}	2.418E+00 Ω
R_{th6}	8.346E-01 Ω
R_{th7}	4.766E-02 Ω
R_{th8}	2.714E-04 Ω

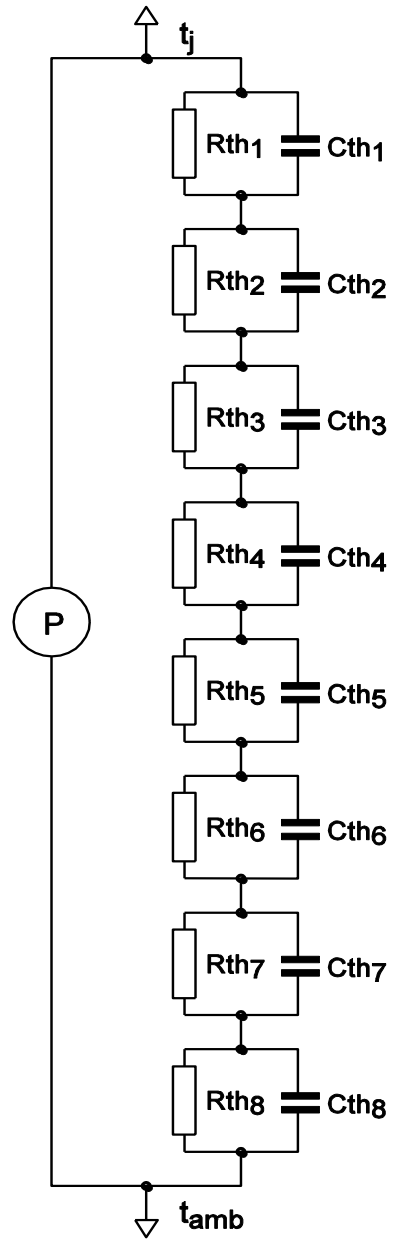

001aal768

Part: BUK7M33-60E
 Date: 3/3/2016
 Model Rth 3.40 K/W